



RECURDYN

Professional Multi Flexible Body Dynamics Simulation Software

- Professional
- MFBD
- Particles & Particleworks
- Control
- CoLink
- Automation / Customization
- Optimization
- Toolkits

The Concept of Multi-Body Dynamics

Multi-Body Dynamics predicts the dynamic behavior of an assembly in motion, where forces may be applied to one or more rigid bodies that are connected to each other through kinematic constraints or contacts. It uses rigid bodies to perform a transient analysis, which allows you to obtain results quickly. MFBD (Multi Flexible Body Dynamics) is a technology that analyzes the dynamic behavior of systems in motion which include both rigid and flexible bodies. The use of flexible bodies provides more accurate results for many applications because the vibration and structural damping of the flexible bodies is included in the simulation.

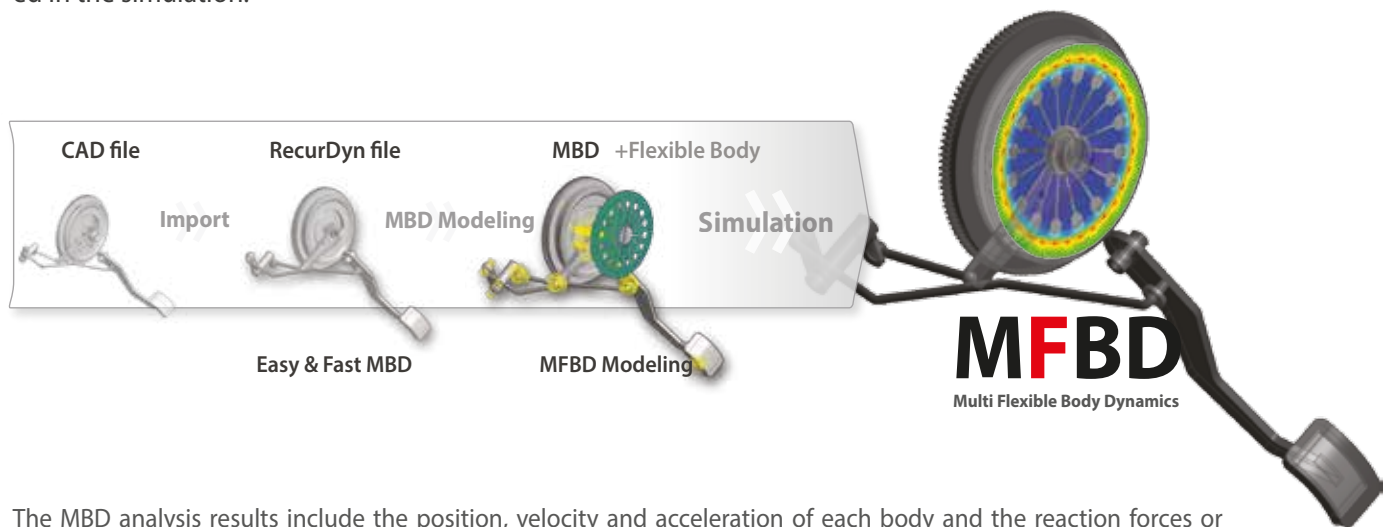

The MBD analysis results include the position, velocity and acceleration of each body and the reaction forces or frictional forces at each constraint (joints, etc.) as well as forces at each contact. With these outputs, you can view and understand the dynamic behavior of the system. Flexible bodies output stress and strain.

These outputs can also be used as input values for structural analysis or durability analysis. When analyzing an MFBD model, it is possible to verify the results of a flexible body's deformation, stress and deformation rate. These outputs can be also used to better understand the behavior of the assembly.

You can create and simulate virtual models instead of building real mechanical systems, reducing the costs and time required to design and develop a product.

MBD is widely used in many industries, including automotive, aerospace, industrial machinery, construction, electrical/electronics, and defense. MBD is used to predict the dynamic behavior of a system, load calculation and vibration, and to simulate mechatronics systems such as robots, which require precise control. It is also used to simulate the coupled interaction between solid bodies and fluids in motion (lubricant in an engine or water behavior in a washing machine, etc.)

Easy modeling with **fast and accurate analysis**

of rigid and flexible bodies using various toolkits

System analysis, component analysis, and durability analysis in a **single environment**

RECURDYN

Five Advantages of RecurDyn

1

Pre/Post environment specialized for MBD analysis

MBD analysis requires a complete modeling environment to enable the definition of a variety of mechanical systems, including the definition of inputs and post processing (animation and plotting). RecurDyn provides a fast and efficient modeling environment. The MBD optimized UI is based on the feedback from experts and engineers in the field of MBD.

2

Fast, accurate and diverse Contact library

Sophisticated technology is required to calculate contacts in a mechanical system. RecurDyn enables you to quickly and accurately analyze contacts in a complicated model using world-class contact algorithms. In addition, the Contact library is optimized for specific geometries such as ellipsoid, cylinder, or box.

3

Analysis of the motion of an assembly containing rigid and flexible bodies

MFB technology can accurately simulate a system containing rigid and flexible bodies. It is possible to simulate nonlinear elastic cases including contact and large deformation as well as linear elastic cases. The processes of mesh creation and durability analysis are also supported within RecurDyn.

4

Various application toolkits

Various toolkits support complex sub-systems, including: media transport products such as printers and copiers; track assemblies on products such as construction machinery, military vehicles and recreational vehicles; machinery components such as gears, belts, and chains. The toolkits allow the user to perform modeling for a specific industry field quickly and easily and then conduct an accurate analysis of complicated mechanical systems with specialized solvers.

5

Scalability for multidisciplinary integrated analysis

RecurDyn provides the scalability for multidisciplinary integrated analysis such as simulation between the mechanical system and fluids through co-simulation with CFD software, control system simulation through co-simulation with Simulink, AMESIM, SimulationX (etc.), and optimal design of mechanical systems using robust optimization algorithms.

Product Components

RecurDyn combines dynamic analysis of rigid bodies and nonlinear flexible bodies experiencing large deformations and contact with control system analysis, optimization, and particle-based fluid and granular material analysis using the MPS and DEM methods.

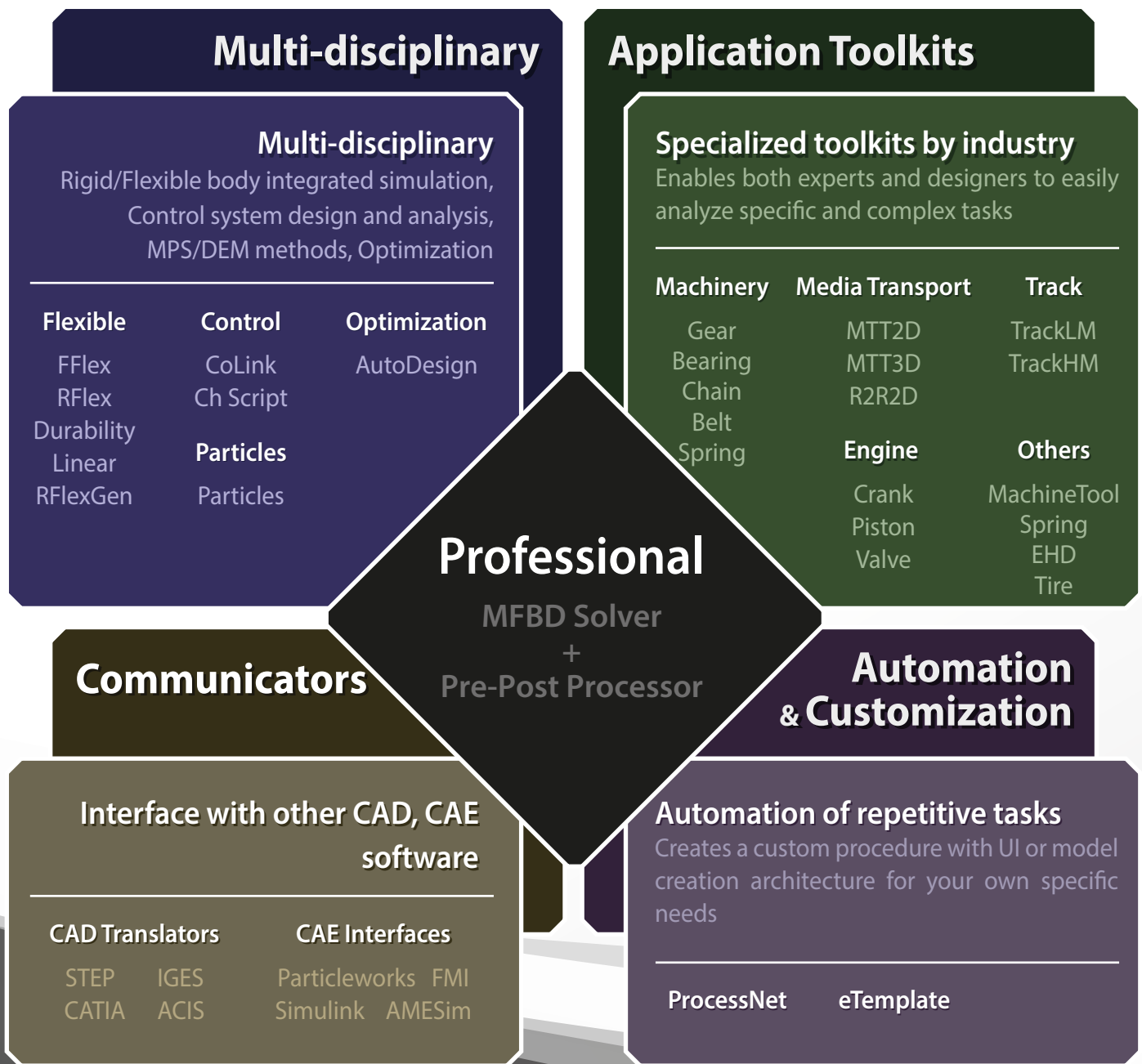

■ Various application examples

■ Automobiles

You can analyze the dynamic behavior or calculate the load applied to each component by performing dynamic analyses on the full vehicle, suspension, engine, and clutch, considering various driving and operating conditions.



■ Camera

You can analyze the behavior of a camera lens barrel during zoom operations based on the operation of the camera gear train.



■ Robot

You can use dynamic analysis to calculate the dynamic load applied to each connection when the robot moves in various ways.



■ Landing Gear

You can analyze the retractable mechanism of the landing gear as well as the vibrations, sliding and the load applied to the landing gear when the airplane takes off or lands.

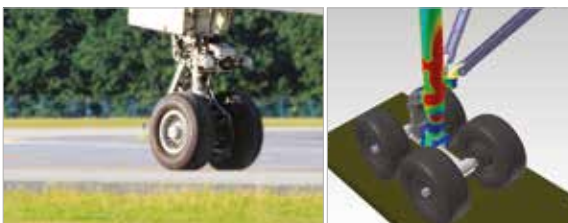

■ Construction Machinery

You can use analysis to calculate the load applied to each component during the digging and transport operations.



■ Printer, Flexible media

Design transfer systems using a model that considers detailed sheet behavior, sensors, air resistance, suction power and static electricity.



■ Machine Tools

You can calculate the load applied to each connection when a machine tool is in use.



* In addition, RecurDyn is widely used in many other fields including the defense industry, agricultural machinery, and biotechnology.

Professional

RecurDyn's intuitive and sophisticated GUI runs on the Windows operating system.

RecurDyn includes various libraries of bodies, joints, and forces for rigid body modeling as well as various contact libraries that enable you to easily model mechanical systems. The rigid body solver, which is based on a recursive formulation, can perform dynamic and static analyses (and others) quickly, accurately, and robustly. RecurDyn also includes various functionality to aid in the analysis of the results such as 3D animations and plots.

Intuitive UI

The UI allows designers to perform modeling quickly and conveniently.

High-Performance Graphic Engine

The MBD-optimized graphics engine easily manipulates complex models.

Easy modeling of rigid body geometry:

High compatibility with CAD software because of the embedded Parasolid Kernel (Imports CAD data in Parasolid, STEP, IGES, STL, ACIS, CATPart, and CATProduct formats)
Support for geometry creation and editing (even for imported geometry)

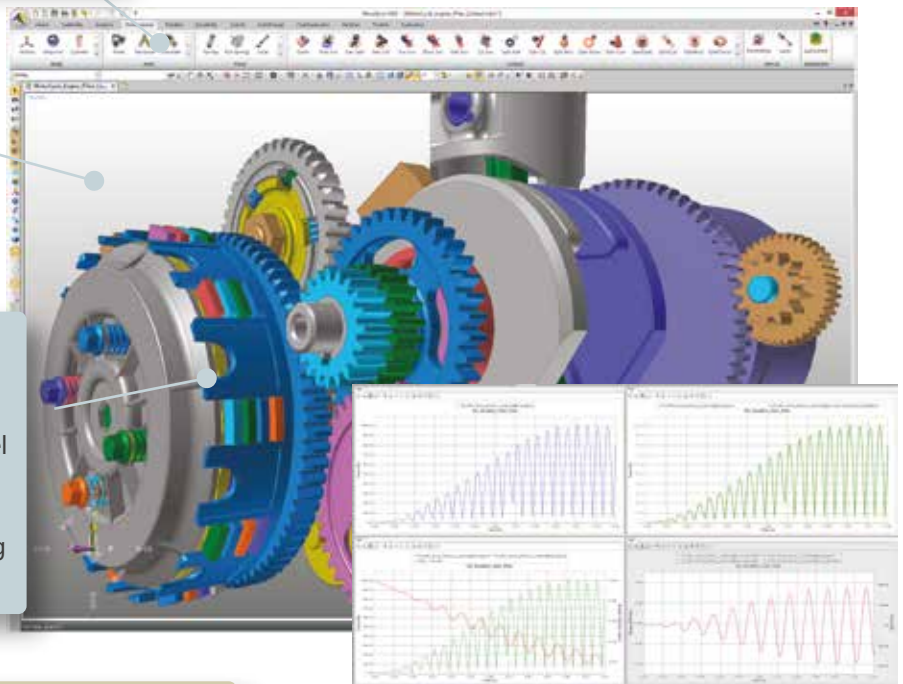

Fast and Accurate Solver

The recursive formulation and the implicit G-Alpha integrator perform simulations quickly, accurately, and robustly. The contact algorithms of RecurDyn are exceptionally robust, enabling the analysis of problems with complex contacts.

Fast and Convenient Post-Processor

The animation and plot outputs allow you to easily and intuitively examine the results of a dynamic analysis, such as the magnitude and direction of the displacements, velocities, accelerations, and forces.

■ Various contacts

■ General Contact

- Available for any geometry
- Contacts are readily defined for imported CAD geometry.



- Contact elements based on Hertzian theory (Nonlinear stiffness)
- Consideration for friction effects (Kinetic friction/Static friction, Linear/Nonlinear)
- Easily definable contact among multiple bodies

■ Primitive(Analytical) Contact

- Faster and more accurate analysis is possible for specific geometries (Sphere, Cylinder, Box, Torus, etc.)



- Noise reduction of contact forces through a smoothing algorithm
- Magnitude and direction of contact force displayed on the screen
- Multiple, distributed contact forces displayed (Geo Contact family)

■ Various Joints and Forces

- Support for various joint and force elements necessary for mechanical system modeling
- Gear, Coupler, Point on Curve, Curve on Curve
- Special force elements such as Beam Force, Plate Force



■ Subsystem

- Complexity reduction and enhanced recyclability by modeling each sub-assembly in the system independently

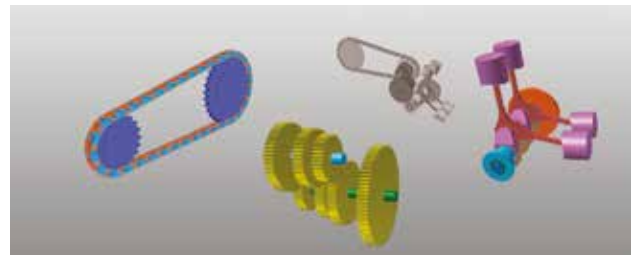

■ General purpose (Universal) sensor

- Capable of modeling two types of general-purpose sensors (box and laser)

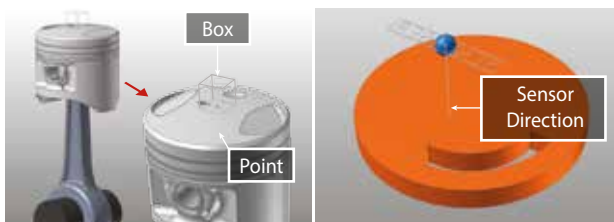

■ Function modeling with text expressions

- Formula definition using various math functions and functions that extract current values in the model during simulation
- Ability to define time-varying position of body, force, and user defined constraint equations
- Ability to process analysis results(results after analysis) into desired quantities
- Objective function definition for DOE and optimization

■ Post Processor

- Result verification using an integrated Post Processor
- System's movement verified through animation
- Plots display position, velocity, acceleration and reaction force
- Contour plot for time-varying stress and deformation rate that can be confirmed by animation and output to AVI file.
- Easy to export data to a file that can be opened with Excel
- Various processing functions such as interpolation, calculus, FFT and filter
- Gap measurement / Interference Check
 - You can determine the minimum distance between multiple bodies or detect interferences.
 - You can determine the changes in values through animation after analysis.

■ Relation Map

- Easy to read diagram that shows the topological relationship of the various elements in the multibody dynamics model

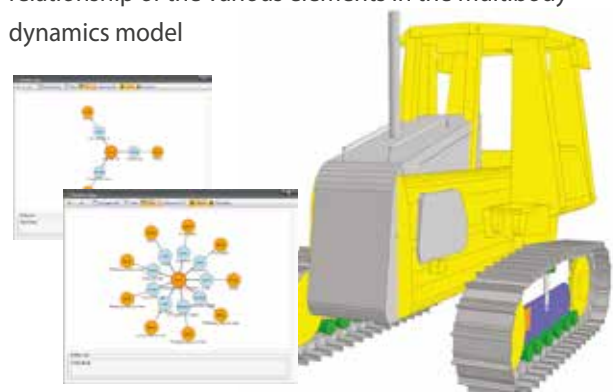

MFBD

MFBD (Multi Flexible Body Dynamics) in RecurDyn is a technology to analyze the dynamic behavior of systems which include both rigid bodies and flexible bodies. It is the combination of MBD (Multi-Body Dynamics) analyzing the rigid body motion and the Finite Element Method (FEM) to analyze the motion, stresses, and deformation within flexible bodies. RecurDyn's solver combines with these two components into a single solver. RecurDyn is much faster and more robust than a co-simulation approach.

Two flexible body formulations are supported in MFBD in RecurDyn. One is modal superposition, in which the deformation of a body is represented by a set of linear mode shapes obtained from an eigen analysis of the flexible body. The other is the nodal (or mesh-based) method, in which all nodal degrees of freedom are considered. The nodal method supports both nonlinear geometric deformation as well as nonlinear material formulations, such as plastic strain and large-strain rubber-like hyperelastic materials. RecurDyn's powerful analysis environment combines both the modal and the nodal methods into the same solver, giving RecurDyn an incredibly robust, fast, and reliable solver.

Flexible body meshes can be either imported from externally created FE meshes, or the meshes can be conveniently created directly inside of RecurDyn using its built-in mesh engine. RecurDyn is the first Multi-Body Dynamics analysis software to incorporate a mesher, allowing the user flexibility and convenience in MFBD modeling and analysis.

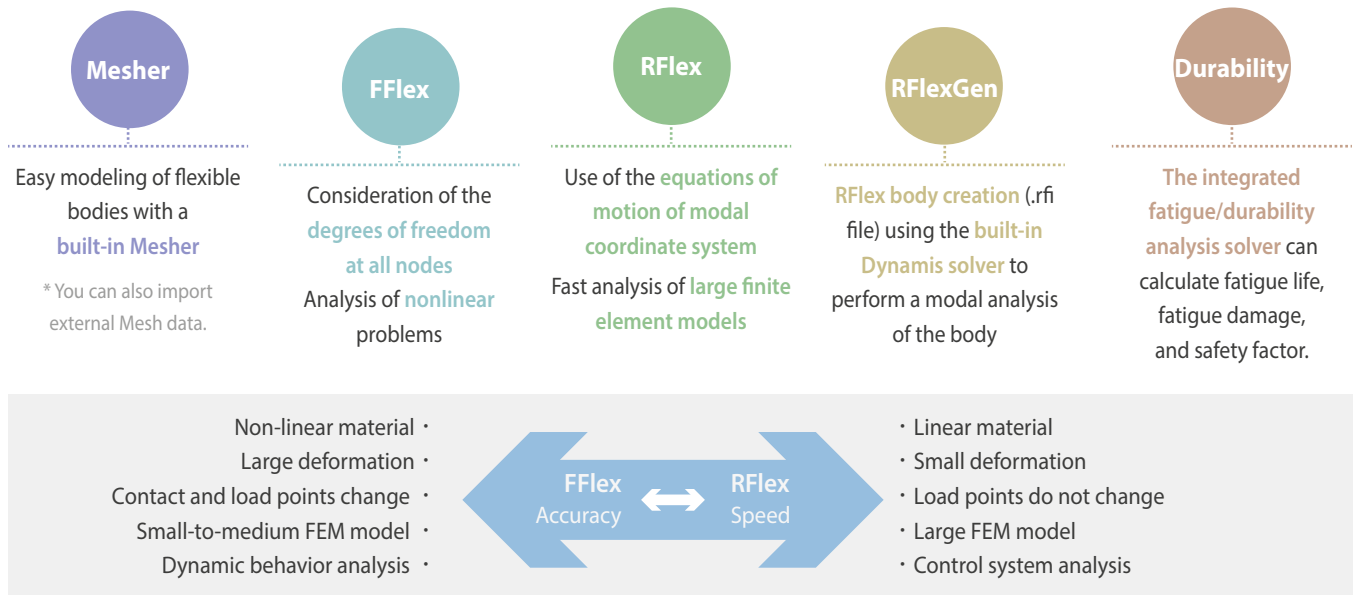

MFBD modeling and analysis highlights

- FFlex and Rflex can be used at the same time.
- Mesh-Pre-Solve-Post (one-stop process) within RecurDyn
- Convenient conversion of Body type (Rigid↔Flexible)
- Existing Joint, Force and Contact connections are preserved when the body type is converted.

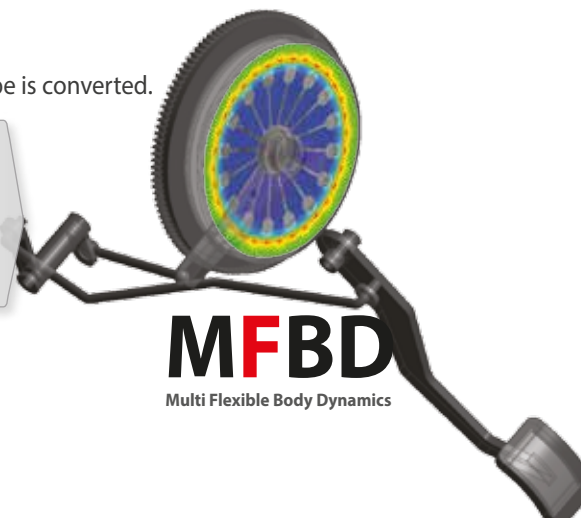
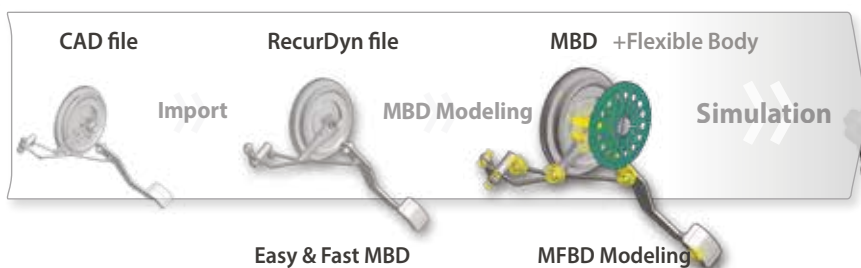

MFBD
Multi Flexible Body Dynamics

■ Modeling and Analysis Process in MFBD

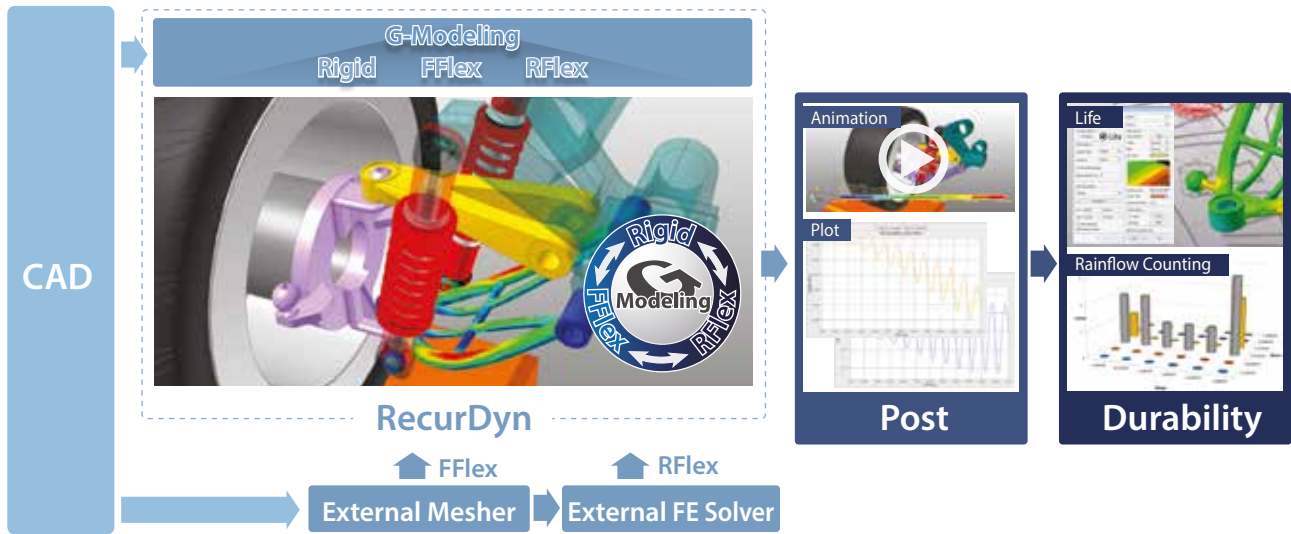

■ Differentiators of MFBD

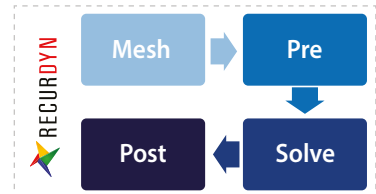
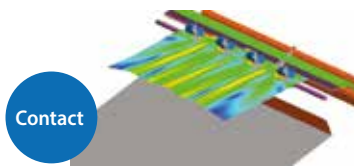
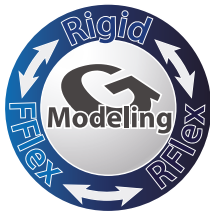

Convenient conversion of Body type
(Rigid ↔ Flexible)
(existing Joints/Forces/Contacts are preserved)
Same Joint/Force/Contact can be used
regardless of the body type.

Contact between different types of bodies
(Flexible-Flexible / Rigid-Flexible / Rigid-Rigid)
Self Contact between surfaces on the
same flexible body

One-stop process within RecurDyn

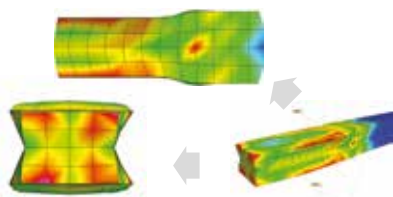

Nonlinear material properties

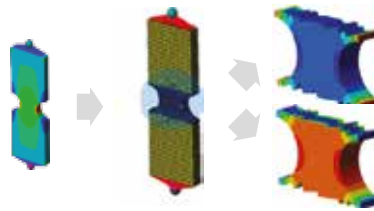

Durability Analysis using
MFBD analysis results

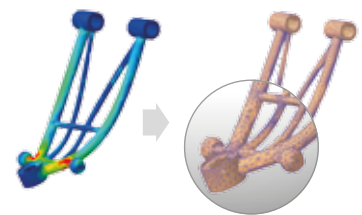

Extract mesh data from the analysis result
(Preserving Residual stress)

■ Other features of MFBD

- 2D and 3D contacts
- Boundary conditions can be defined for individual nodes.
- Support for various rigid body elements (Rigid, Interpolation)
- Support for various elements (Beam, Shell, Solid, Rigid)
- Fast analysis using SMP support
- The results can be output in the FEMFAT format.
- Nodal flexible bodies can be created by importing mesh data generated externally (ANSYS, Nastran, Design Space formats are supported).
- Modal flexible body can be created by importing modal analysis results generated by external FEA software (ANSYS, Nastran, IDEAS, RADIOSS/OptiStruct and Simulation Mechanical are supported).

Particles & Particleworks

RecurDyn offers the ability to analyze MFB systems that interact with either granular (dry) particles or particle-based fluids. Granular solids, such as soil, sand, or printer toner, are modeled using RecurDyn/Particles, which is based on the discrete element method (DEM). Fluid dynamics is available through co-simulation with the MPS-based CFD software Particleworks. RecurDyn has an interface for Particleworks that makes co-simulation between them simple.

■ RecurDyn/Particles

Modeling and Analysis of solid particles such as dirt, gravel and sand using DEM (Discrete Element Method)

- Analysis considering the interaction between the MBD model of the mechanical system and the solid particles
- From particle creation and contact definition to analysis and animation within RecurDyn
- Fast analysis of tens of thousands of particles using GPU computing
- Mixing analysis of solid particles having different properties and sizes
- Support for the moving path and number measurement of solid particles, contour for contact force



■ RecurDyn/Particleworks Interface

RecurDyn has an interface specially designed for co-simulation of dynamics of rigid bodies and fluids based on the MPS (Moving Particle Simulation) method.

- Intuitive UI for easy modeling of co-simulation with Particleworks
- Animation of fluid particle results analyzed in Particleworks can be shown with the RecurDyn models within RecurDyn.
- Visualizing the outer line of fluid particles in 2D Profiles
- Measuring the number of fluid particles in a specified area for each time interval
- Fast analysis of fluids with millions of particles using GPU and HPC

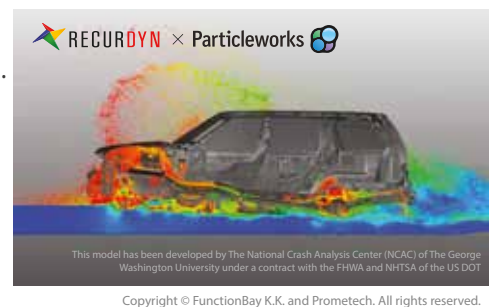

Copyright © FunctionBay K.K. and Promotech. All rights reserved.

■ Example - RecurDyn x Particleworks Co-Simulation

■ Reaction torque from lubrication oil on a single cylinder engine at various temperatures

- Demonstrates the relation between the viscosity and reaction torque caused by the lubrication oil at various temperatures
- Predicts the differences in deceleration at different lubrication oil viscosities caused by variations in temperatures

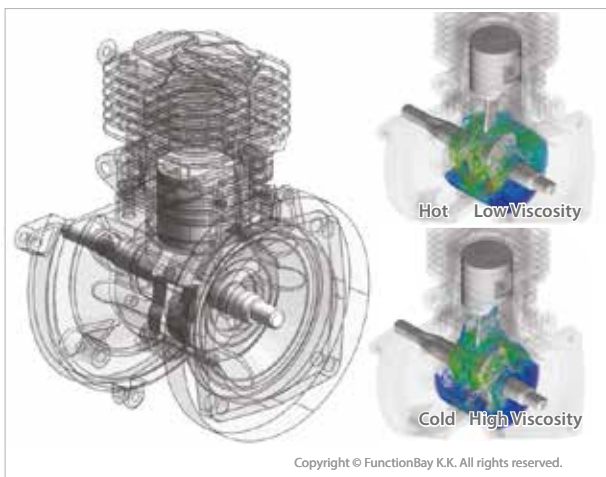

Copyright © FunctionBay K.K. All rights reserved.

■ Fluid impact on the underbody of a vehicle when driving through a puddle

- Simulates the fluid impact on the underbody of a vehicle
- Shows the flow of the splashed water around parts accessible from the underside of the car, which is especially important for electric and hybrid cars

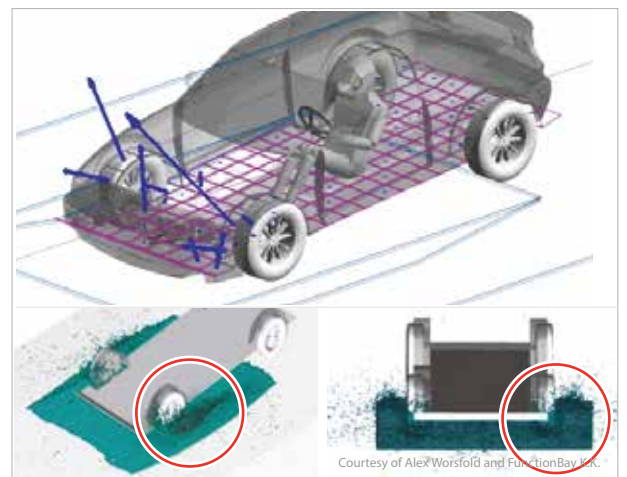

Courtesy of AlexWorsfold and FunctionBay K.K.

RecurDyn has an interface specially designed for co-simulation of dynamics of rigid bodies and fluids. RecurDyn is the world's first commercial multibody dynamics software to offer such an interface. This interface allows you to simulate complicated fluid-solid interactions that were very difficult to simulate in the past. You can now simulate the coupled interaction between the two easily, so that the solid bodies and the fluids affect each others' behaviors.

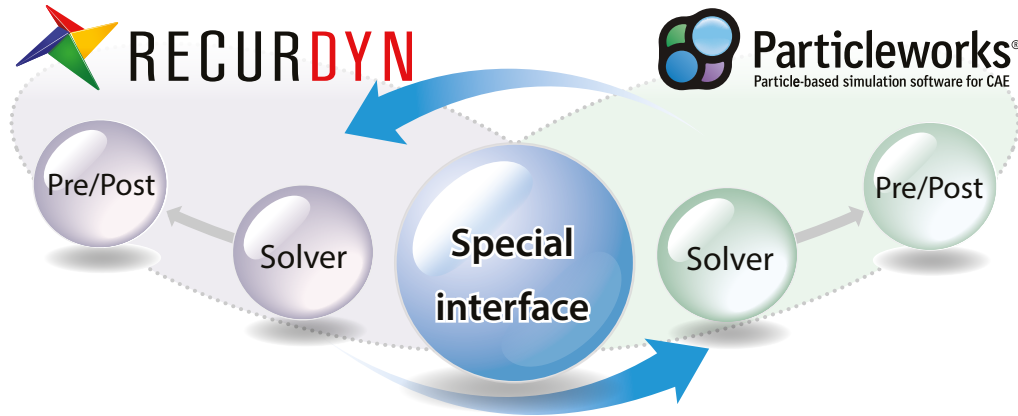

- RecurDyn/Particleworks IF is a special interface in RecurDyn designed for co-simulation of MFBD in RecurDyn with fluid dynamics in Particlesworks from Promotech. Particleworks is a computational fluid dynamics (CFD) software based on the Moving Particle Simulation (MPS) method.
- Through co-simulation with Particleworks, the analysis of the coupled interaction between a mechanical system and a fluid can be analyzed.
- The streamlined co-simulation interface provides coupled MFBD-fluid simulation in a simple analysis environment.

■ Features of Particleworks

ParticleWorks allows you to analyze fluid behavior precisely and stably without a mesh so that the flow of liquid such as water or oil can be represented using the particles.

It is possible to analyze free surface problems having contacts between two fluids such as water and air or moving-boundary problems. Particleworks also lets you analyze tens of thousands of particles and large scale analysis using GPU and compute-cluster hardware, making it ideal for co-simulation with dynamic analysis and can further widen its scope through co-simulation with RecurDyn.

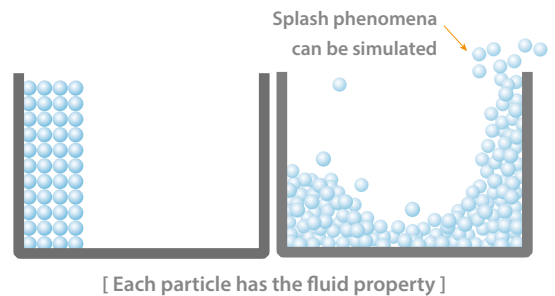

■ RecurDyn & Particleworks Co-simulation

- Captures the effects of the motion of the mechanical system on the fluid
- Captures the effects of fluid behavior on the mechanical system
- The effect of the behavior of the mechanical system can be seen in the surfaces and turbulence of the fluid.

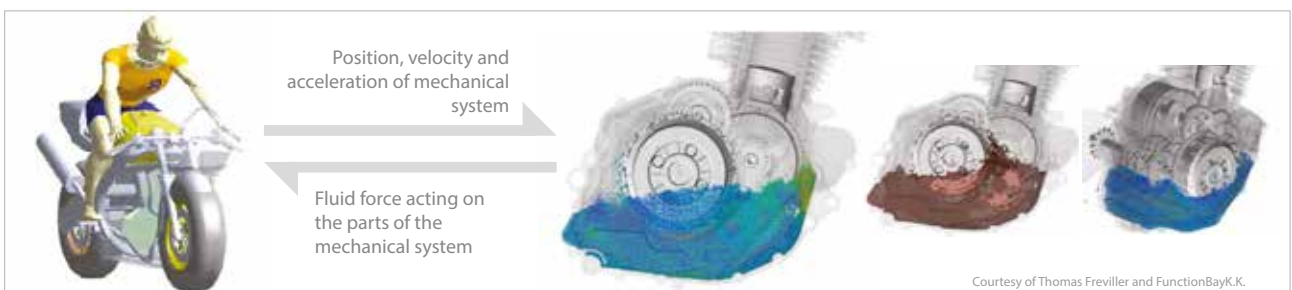

Control

Accurate and robust models of a mechanism are required for the design and parameter optimization of control system algorithms, as well as their reliability verification. RecurDyn provides a diverse set of tools to analyze mechanism models coupled with the control system algorithm.

RecurDyn provides an interface for co-simulation with the MATLAB/Simulink and AMESim software that is widely used in mechatronics. In addition, RecurDyn supports FMI to incorporate the use of Modelica-based applications. RecurDyn/CoLink allows for fast and accurate control system analysis through the deep integration of the control simulation code with RecurDyn's dynamics solver.

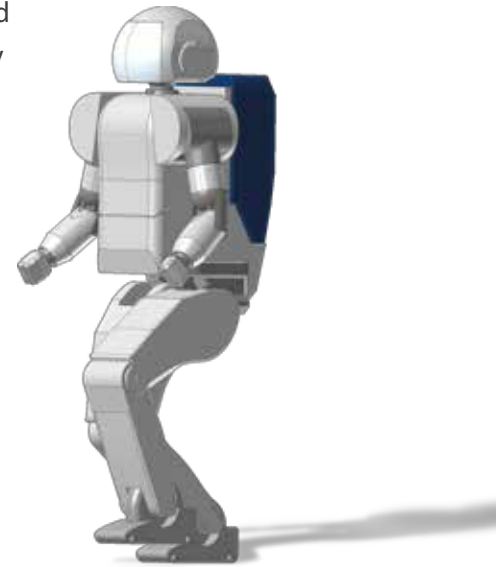

■ Matlab/Simulink

RecurDyn/Control includes an interface for co-simulation with MATLAB/Simulink and Simplorer.

This allows mechanical systems that contain control and drive systems, such as controllers and motors, to be analyzed.



■ Simulink Interface

- RecurDyn/Control includes an interface which allows it to utilize a realistic dynamic model of RecurDyn in a MATLAB/Simulink model.
- It is possible to use a RecurDyn model including contacts or flexible bodies as well as various joints or forces in the model created by Simulink.
- A RecurDyn model can be integrated with a Simulink model using a UI which easily creates an S-Function for the RecurDyn Plant model.

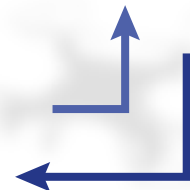
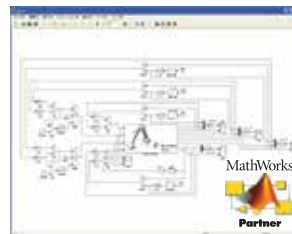

■ AMESim

RecurDyn/Hydraulic includes an interface for co-simulation with the AMESim hydraulic analysis software. This allows mechanical systems that contain a wide range of hydraulic systems to be analyzed.

■ FMI (Functional Mockup Interface)

RecurDyn supports FMI, a standard interface based on Modelica, and co-simulation with applications that support FMI.

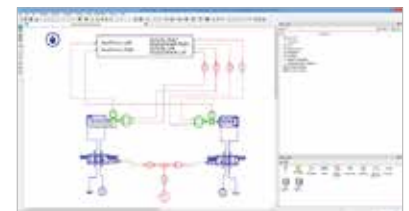

CoLink

RecurDyn/CoLink, a control system simulator integrated into RecurDyn, allows the user to model complicated control systems, electrical systems and hydraulic systems. It also provides a platform for integrated analysis of firmware design, electronics design and mechanical system design by connecting with RecurDyn model.

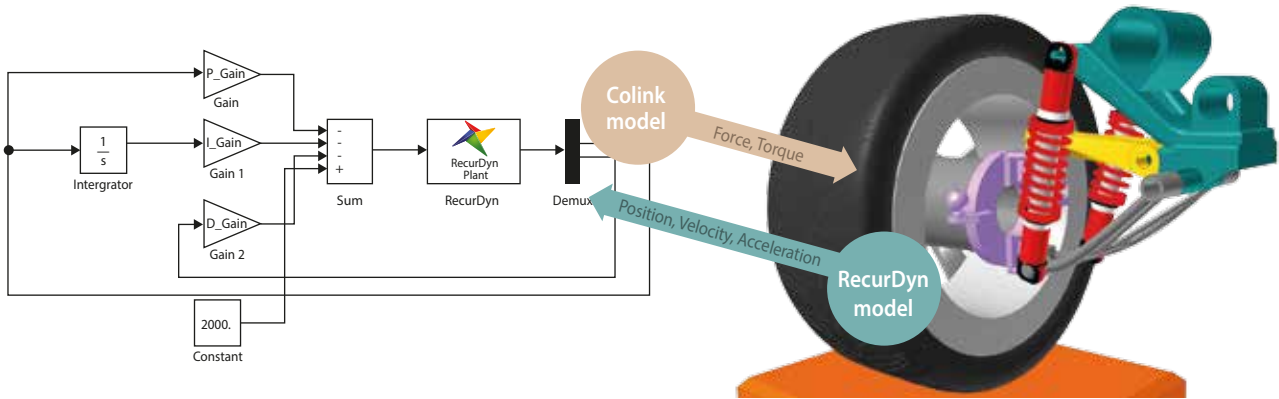

■ Simple modeling using block diagram

Modeling of a complicated mechatronic system can be easily performed because it is possible to represent a control system with a logical block diagram. The data transfer between the controller and the mechanical system is clearly defined.

■ Various block libraries

Frequently used block libraries in the electrical / electronic / control system are provided to allow the user to easily create a complicated controller.



■ Fast simulation using the integrated solver with RecurDyn

An integrated solver can simultaneously analyze the dynamic model and the controller as a continuous system and provide a fast and accurate analysis.

A discrete system can also be analyzed by co-simulation

(A CoLink model with no connection with a RecurDyn model can be also analyzed).

■ Example - Copier control simulation



- When a sensor detects a sheet, a roller starts operating and transports the sheet.
- It is possible to verify the change of sheet properties (bending / crumpling) or proper operation timing in advance (CoLink and MTT2D are required).

■ Example - Hydraulic control simulation of lifting equipment attached to an agricultural machine



Courtesy of NewtonWorks Corporation and FunctionBay K.K.

- It is possible to verify the complex lifting behavior in an agricultural attachment with a hydraulic cylinder in advance.
- This was done using co-simulation between RecurDyn and SimulationX (1D-CAE Software) using FMI.

Automation / Customization

The design and simulation of a mechanical system can be made more efficient by the automation of repetitive tasks and the use of customized user interfaces. RecurDyn provides a specialized environment for the automation of repeated tasks and creating custom UI.

■ RecurDyn/ProcessNet

RecurDyn/ProcessNet is a powerful, script-based customization environment that is built into RecurDyn/Professional. RecurDyn/ProcessNet allows users to create their own GUI features for RecurDyn/Modeler that can manipulate model data, create customized dialog boxes and UI features, automate tasks, and encapsulate domain knowledge and best practices. RecurDyn/ProcessNet can access and manipulate both pre-processing data as well as post-processing data. RecurDyn/ProcessNet uses Microsoft.NET for the scripting environment. Scripts can be created using various .net languages, and documentation is provided for C# and Visual Basic. Through RecurDyn/ProcessNet users can dramatically extend the functionality of RecurDyn/Professional to meet their unique simulation requirements.

- Various RecurDyn API allow you to develop a variety of customized features using C#.
- Automation of repetitive tasks and personalized UI development are available using simple programming.
- RecurDyn Library + C# Language



■ RecurDyn/eTemplate

- RecurDyn/eTemplate is a tool that enables RecurDyn model data to be stored in Microsoft Excel spreadsheets. RecurDyn/eTemplate can read the spreadsheet data and create the RecurDyn model.
- RecurDyn/eTemplate is extremely powerful, yet simple, intuitive, and easy to use. It can be used as a powerful customization tool to make managing model data much more efficient.
- Through eTemplate, users with little experience with RecurDyn can create and modify models and perform powerful analysis.

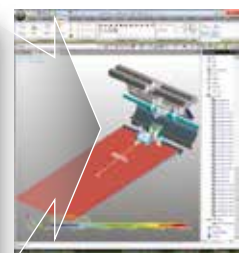

■ RecurDyn/Expression Helper

The RecurDyn Expression Helper helps you to more efficiently build expressions which are frequently used during system modeling. You can create various expressions by inputting intuitive parameters using Excel.

The Expression Helper can be downloaded for free from FunctionBay Technical Support website (<http://support.recurdyn.com/>).

Optimization

Designing a mechanical system often involves optimizing the design variables with respect to specific performance metrics. RecurDyn provides a high performance optimization tool, AutoDesign, that requires very little knowledge of optimization to use because of its straightforward user interface.

■ Unique characteristics of AutoDesign

- Easy and intuitive interface which allows anyone to use with a little practice
- The world's first progressive meta-model algorithm, motivated from Bayesian Global Optimization
- Easy definition and customization of the design variables and objective functions
- Robust design optimization techniques to consider uncertainties such as tolerances and noises
- Multi-scale optimization techniques to solve the problems which have the different scales of design variables
- Easy and powerful multi-objective optimization algorithm which can be used regardless of the number of objectives
- Optimization with very small number of trials

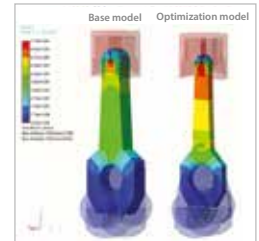

For example, it used only 116 analyses to optimize a design that had 105 design variables and 14 performance indices.

■ Various features of AutoDesign

■ Design Study : Design Study provides 6 methods for DOE (Design Of Experiments)

- Provides ways to perform DOE with the optimal number of samplings
- 2-level and 3-level orthogonal array experiments are automatically generated according to the number of design variables.
- Descriptive DOE which allows the users to define the level and the number of experiments
- Effect analysis, screening variables and correlation analysis are supported.

■ Design Optimization : Design Optimization provides the functions for optimization of the system using the meta-model.

- Progressive meta-model based on optimization technique is employed to reduce the number of trials (analyses).
- Even beginner users can use optimization using automated methods.
- Various options are supported for the experienced users.
- The existing optimization results can be reused.
- All difficult selections of optimization algorithms are automated.

■ DFSS/Robust Design Optimization : Optimization for DFSS (Design for Six Sigma) is supported.

- Progressive meta-model based on optimization technique is employed to reduce the number of trials (analyses).
- Approximate variance of performance during optimization process can be estimated.
- Users can define the tolerance and deviation of random design variables and random noise.
- Adaptive 6-sigma inequality constraints are considered unlike the other optimization tools which focus on only statistical dispersion.
- User can define the robustness of objective functions.

■ Reliability Analysis : Revolutionary algorithm of Reliability Analysis can produce reasonable reliability results with a smaller number of samplings than the traditional methods.

- SAO Hybrid Method: Powerful Reliability algorithm which is integrated with Progressive meta-model based on optimization techniques and MPP-based DRM (Dimension reduction Method)
- Adaptive Monte-Carlo Method: New method which uses sequentially adaptive Monte-Carlo algorithm to minimize the number of sampling points

Machinery

The machinery toolkits contains customized UIs to facilitate the modeling of the elements of mechanical systems common to machinery, such as gears, chains, belts, bearings, and springs. These toolkits have specialized solvers optimized for these elements. This allows the user to perform modeling quickly and easily and conduct an accurate analysis of complicated mechanical systems.

■ RecurDyn/Gear

The RecurDyn/Gear toolkit is used to define and analyze systems of gears. It defines the gear geometry, the contact surfaces, and it provides a specialized solver code for the gear system.



- Various gear libraries
 - Spur Gear · Helical Gear · Scissors Gear · Spur-Internal Gear · Helical Internal Gear
 - QFB (Quasi-Flexible Body) Gear · Worm & Worm Gear (Single-Enveloped) · Bevel Gear (Straight Type, Spiral Type, Zerol Type)
- You can confirm the vertical force and friction force occurring at a contact point.
- Vibrational characteristics of gear and DTE (Dynamic Transmission Error) can be analyzed considering Backlash and tolerance.

■ RecurDyn/Chain

The RecurDyn/Chain toolkit dramatically simplifies the modeling of complex chain systems and automatically defines contacts within the chain system, including contacts between the chain links. It also includes a highly specialized solver for chain systems.



- Automatic chain assembly with automatic contact
- Graphical or spreadsheet design of sprocket teeth profile
- Various types of chains
 - Roller Chain · Multiplex
 - Silent Chain
- Various chain system libraries
 - Sprocket · Roller · Guide · Chain Links
 - Lateral Links · Group Guide

■ RecurDyn/Belt

The RecurDyn/Belt toolkit is used for the modeling of belts and pulleys systems. MFB technology can be used, which makes it possible to produce more realistic analyses by modeling belts as flexible bodies.

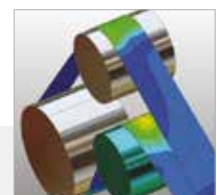

- Automatic belt assembly with automatic contact
- Various types of belts as rigid bodies
 - Flat Belt · V Belt · Ribbed V Belt · Timing Belt
- Various types of belts as flexible bodies
 - Beam · Shell
- Various types of rollers and pulleys
 - Roller · V-pulley · Flange · Ribbed V-pulley
- Crown Roller (You can model a roller as a desired shape using Crown Roller)
- 2D belt and guide for analysis speed improvement

■ RecurDyn/Bearing

• The RecurDyn/Bearing toolkit is used for the modeling of bearing systems. It simplifies the creation of bearings and the contact surfaces.
• The toolkit also supports EHD (fluid) bearings and simulates lubrication properties during analysis (RecurDyn/EHD is required).



- Bearing shape creation and automatic definition of contact between parts
 - Ball Bearing · Roller Bearing
- Consideration for the deformation of outer ring by modeling the flexible body
- EHD Bearing (Combined with RecurDyn/EHD)

Engine

RecurDyn's engine toolkits dramatically simplifies the modeling and analysis of the major components of internal combustion engine systems, such as valves, pistons and crankshafts. This allows you to create and analyze highly realistic engine models quickly and easily.

■ RecurDyn/Valve

- The RecurDyn/Valve toolkit is for the design and analysis of valve train systems. It automates the creation of valve train assemblies.
- This toolkit supports various valve types and camshafts. It also allows for the use of flexible bodies in the analysis.



- Creation of valve train part shape and automatic definition of contact among parts
- Various types of valves
 - Direct-acting
 - Center-Pivoted arm
 - End-Pivoted Arm
 - Push-rod & Center-pivoted arm
- Convertible to a flexible model

■ RecurDyn/Piston

- The RecurDyn/Piston toolkit automates the creation of engine piston systems.
- The toolkit is designed for contact analyses of pistons and cylinders. It can perform a bearing analysis that models the lubrication properties of EHD bearings between a piston pin and connecting rod or between a piston pin and piston (RecurDyn/EHD is required).

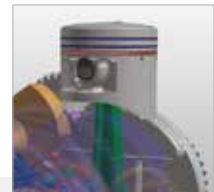

- Easy modeling with part shape creation of piston and automatic definition of contact
 - Piston
 - Piston Pin
 - Connecting Rod
 - Engine Block
 - Liner Connector
 - Engine Mount
 - Gas Force
- Piston pin (Combined with RecurDyn/EHD)

■ RecurDyn/Crank

The RecurDyn/Crank toolkit automates the creation of drive shaft-related parts, such as crankshafts, balancing shafts, and flywheels.

- Easy modeling with part shape creation of crank and automatic definition of contact
- Types of crank train
 - Straight
 - Horizontal
 - V Type
- Types of crank shaft
 - Rigid
 - Beam, Torsional, Torsional + Bending
 - FFlex
 - RFlex
- All parts can be convertible to flexible models.
- Gas Force settings

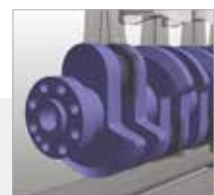

Track

The Track toolkits allow efficient modeling and analysis of the tracked vehicle systems frequently used in construction equipment and military vehicles such as tanks. These toolkits significantly reduce the time needed for modeling and allow for fast and accurate analysis through a specialized solver.

■ RecurDyn/TrackLM

- The RecurDyn/TrackLM toolkit includes various libraries (for example, Track Link, Wheel, and Sprocket) for the simplification of the modeling of the low-speed tracked vehicle systems used in construction and heavy equipment.
- The toolkit includes a UI and analysis solver optimized for low-speed tracked vehicle systems.

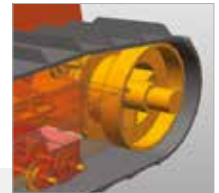

- Automatic track assembly with automatic contact
- Various libraries for tracked vehicles
 - Track Link · Sprocket · Roller Guard · Flange · Roller · Roller Guard
- Graphical design of sprocket teeth profile (lines and arcs) and link grouser profile (line segments)
- Standard proving ground library
- Soil modeling with Bekker's theory
- Link designed by CAD can be used as Link for Track LM.
- Track Link can be converted into flexible body for analysis.
- Study for dynamic performance of vehicle (Ride and comfort), Calculation of dynamic load history

■ RecurDyn/TrackHM

- The RecurDyn/TrackHM toolkit includes various libraries (for example, Track Link, Wheel, and Sprocket) for the simplification of the modeling of the high-speed tracked vehicle systems used in tanks and other military vehicles.
- The toolkit provides a UI and analysis solver optimized for high-mobility tracked vehicle systems.



- Automatic track assembly with automatic contact
- Various libraries for tracked vehicles
 - Track Link (Single, Double, InnerPin) · Sprocket · Single Wheel · Double Wheel
- Graphical design of sprocket teeth profile (lines and arcs) and link grouser profile (line segments)
- Standard proving ground library
- Soil modeling with Bekker's theory
- Study for dynamic performance of vehicle (Ride and comfort), Calculation of dynamic load history

Media Transport

RecurDyn's media transport toolkits are for analyzing transport systems for flexible media, such as paper, films, and cards. This toolkit automates the modeling and analysis of sheets as flexible bodies and dramatically simplifies the creation of rollers and guides, making it the ultimate tool for the layout and design of media transport systems. In addition, the toolkits also include various sensors and tools to model air resistance, suction, and static electricity.

■ RecurDyn/MTT2D

- RecurDyn/MTT2D provides various components for the efficient 2D design of transport systems for thin media such as paper or film.
- 2D modeling and optimized solvers allow for faster analysis.
- Rollers can be modeled as flexible bodies made of materials such as rubber or sponge to capture the effect of roller flexibility on the behavior of the media.

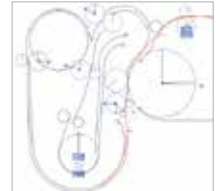

- Fast analysis using 2D modeling
- Various Libraries for transport systems
 - Sheet
 - Fixed Roller
 - Movable Roller
 - Guide (Arc, linear)
- Various sensors
 - Speed
 - Event
 - Distance
 - Tension
- Creating the curled and folded sheet in the initial state
- Automatic definition of contact among Sheet, Roller and Guide
- Support for flexible roller as well as rigid roller
- Air resistance coefficient setting
- Layout design for transport system

■ RecurDyn/MTT3D

- RecurDyn/MTT3D provides various components for the 3D design of transport systems for thin media such as paper or film including the simulation of steering and the onset of wrinkles.
- The RecurDyn/MTT3D toolkit is designed to analyze 3-dimensional media transport systems.
- This toolkit includes an optimized solver that performs analyses quickly, robustly, and accurately.
- The media is modeled as flexible bodies using MFBD technology.

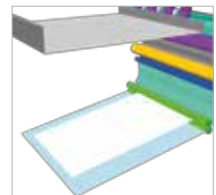

- Analysis of more realistic models using 3D modeling
- Various Libraries for transport systems
 - Sheet
 - Fixed Roller
 - Movable Roller
 - Guide (Arc, Linear, Circular)
- Various sensors
 - Speed
 - Event
 - Distance
 - Tension
- Support for flexible sheet using Shell element
- Definition of air resistance, absorption forces, and electrostatic forces by nodal forces (Node load of Sheets by User Subroutine)
- Air resistance coefficient setting
- Creating the curled and folded sheet in the initial state
- Automatic definition of contact among Sheet, Roller and Guide
- Providing the contour information to the displacement, stress, and strain within a sheet
- Layout design for transport system, analysis for various 3D characteristics

■ RecurDyn/R2R2D

- RecurDyn/R2R2D provides a variety of libraries for the 2D design of Roll to Roll systems.
- Fast and accurate analysis using optimized solver for Roll to Roll system.
- RecurDyn/R2R2D is especially optimized for winding behavior analysis and supports automatic definition of media that includes multiple winds around a spool or roller.

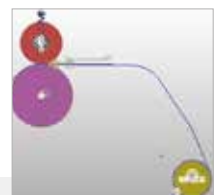

- Fast analysis using 2D modeling
- Automatic web generation function using beam elements
- Automatic definition of contact among Web, Roller and Guide
- Providing the contour information to the displacement, stress, and strain within web
- Various libraries for Roller to Roll system
 - Circle Roller
 - General Roller
 - Guide (Arc, Linear, Circle)
- Various sensors
 - Speed
 - Event
 - Distance
 - Tension

Other Toolkits

RecurDyn/Spring (Multi Mass Spring)

- Easy and fast modeling of springs that have dynamic responses that are a function of the mass with the coils of the spring
- It can be used to show different behavior depending on the position of the spring or to consider contacts between spring coils.



- Type A : linear spring model that considers the collision between coils
- Type B : model using BMW's algorithm (nonlinear spring modeling using spline)
- Type C : model using YAMAHA's SAKAI algorithm (nonlinear spring modeling, dual-rate spring modeling)
- Type D : 3D MMS consisting of beam force and contact element

It has non-linear characteristics and is capable of expressing the contact between spring self contact and type D spring.

RecurDyn/EHD

- Simulates contacts that occur through a film of oil
Example applications are bearings on a crankshaft or a camshaft, or a piston sliding in a cylinder.
- RecurDyn/EHD calculates the thickness of the oil film and the corresponding pressure and force from the behavior information of the mechanical system. The effect of this pressure on the body is also taken into account in the simulation.

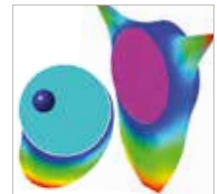

- Algorithm options for RecurDyn / EHD
 - RDEHD (an E-CFD algorithm developed by FunctionBay)
 - MEHD (an algorithm developed by MAGNA STEYR)

RecurDyn/Tire

RecurDyn/Tire provides a library to simulate the tires used in vehicles. Various types of tire modules (UA, Fiala, FE-Tire, MF-Tyer, MF Swift) are supported, depending on the application.



- Easy modeling of tires using Tire Group
- Easy conversion between tire models
- Supports for MF-Tire and MF-Swift of TASS (previously TNO) allows the user to represent three dimensional surface contact, vibration and slip phenomenon.
- Supports for F-tire of COSIN allow the user to support various tire modeling including flexible ring tire model.

RecurDyn/MachineTool

RecurDyn/MachineTool allows manufacturers of machine tools to utilize MBD more easily and efficiently. It was developed based on the demands of manufacturers in the field using the joint efforts of Function Bay, IWB (Technical University of Munich), and FRAMAG (machine tool manufacturer).

- Various levels of modeling capabilities are provided that consider various aspects of machine tool simulation.
- Analysis of ball screw motion drives, linear guides and bearings
- Analysis of models experiencing large motion including flexible bodies
- Data from suppliers' catalogs can be used for analysis.
- Functions for standard operation such as ISO circularity test
- Analysis of a motor with controller using CoLink

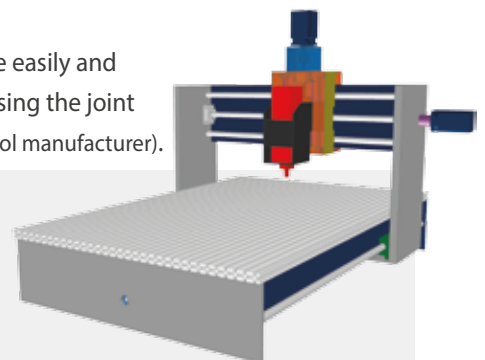

RecurDyn Support Site <http://support.recurdyn.com>

The Technical Support website is designed for all types of users of RecurDyn software. It not only describes the basics of how to use the software but also provides useful tips and learning materials about computer-aided engineering (CAE), and tutorials to help users efficiently utilize CAE software.

* Updates on the Technical Support website will also be posted on the RecurDyn Facebook account. [facebook.com/recurdynotech](https://www.facebook.com/recurdynotech)



■ FAQ. Instructions and practical tips

FAQ-style tips to help users understand RecurDyn software easily. FAQs were created by analyzing questions frequently asked by users and content that was not included in the tutorial.

■ Knowledge Base. Tutorials and advanced tips for using CAE software

Easy-to-learn tutorials and advanced technical tips on how to take full advantage of RecurDyn are provided to improve your training and competency.

■ Blog. Product information, success stories, and special reports

Provides news on our product, RecurDyn and activities, customer success stories, and special articles

■ Forum. Community forum

A community forum where users can receive technical supports for RecurDyn and freely communicate with other users

■ e-Learning. Self-training program for CAE beginners

Provides simple examples to help beginners who want to learn about computer-aided engineering (CAE) perform Multi-Body Dynamics modeling, check dynamic analysis results, and compare CAE software with analytical solutions



Company

FunctionBay, Inc., is a CAE (Computer Aided Engineering) company that specializes in developing and selling solutions for engineering simulation and consulting technologies.

Founded in South Korea since 1997, FunctionBay is globally recognized as a leader in multidisciplinary CAE solutions. We have a global network of sales and support. We have branch offices in Japan, China, Germany, and the United States of America. We have dealer networks in Taiwan, India, Australia, Italy, Switzerland, France, as well as many other locations worldwide.

As a CAE company, FunctionBay is continuously investing in R&D activities including the funding of related research by the world's leading experts.

In order to cope with the rapidly changing CAE market and its users' needs, FunctionBay seeks to listen to customers and solve problems together.

All employees of FunctionBay and its sales channel will fulfill their duties with sincerity and will do their best their best to help customers improve their productivity.

South Korean Certificates/Awards

Presidential Citation on Engineering day by the Ministry of Security and Public Administration

2014 K-Brain Power by the Ministry of Trade, Industry and Energy

ATC (Advanced Technology Center) by the Ministry of Trade, Industry and Energy

Korean World-class Product Award (Present) by the Ministry of Knowledge Economy

Korean World-class Product Award (Next-Generation) by the Ministry of Trade, Industry and Energy

INNO-BIZ Certification by the Small and Medium Business Administration

ISO 9001: 2000 Certification by International Certification Registrar

New Excellent Product Certification by the Ministry of Commerce, Industry and Energy

IR52 Jang Young-Shil Award by Korea Industrial Technology Promotion Association

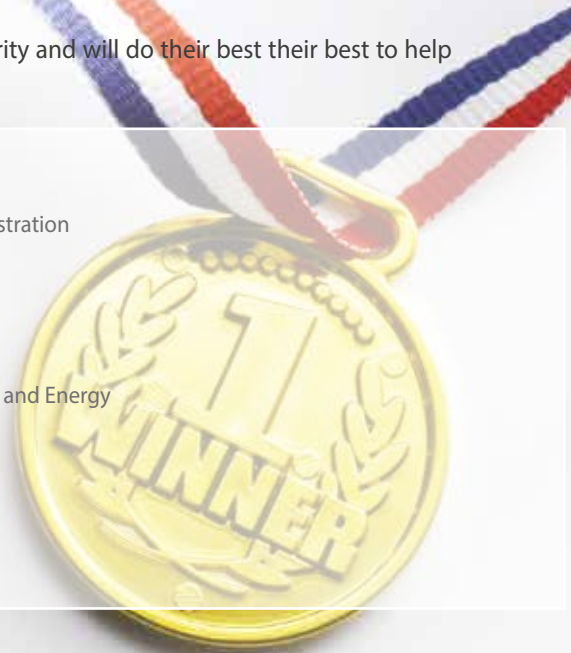

FunctionBay works to make the world a happy and beautiful place for all, including our users and employees as individuals, our families, the people in the world in general, and the world environment. FunctionBay strives for not only the pursuit of customer satisfaction, growth, and profit (needed to stay in business), but also the philosophy: "Benefit the Sellers, Buyers, and People of the World."



FunctionBay's success in the field of mechanical analysis as a CAE professional company in Asia has led to our dream to become a leading CAE company in the world and continuously drives us to reach that goal. Founded in South Korea, FunctionBay, Inc., has local offices in Japan, the USA, Germany, China and the distributor network in Taiwan, India, Australia, Italy, Swiss, France, etc. and partners with leading PLM companies in the world.



FunctionBay embraces a youthful and creative entrepreneurial spirit that supports pure enthusiasm, freedom and fun. FunctionBay strives to create a more exciting and autonomous working environment so as not to lose the driving force to pioneer new fields and constantly improve.





Contact

Korean Headquarters R&D Center

FunctionBay, Inc.

5F, Pangyo Seven Venture Valley 1 danji 2 dong, 625, Sampyeong-dong, Bundang-gu, Seongnam-si, Gyeonggi-do, 13487, South Korea

82+31-622-3700 <http://www.functionbay.com> inform@functionbay.co.kr

Overseas Subsidiaries

Japan. FunctionBay K.K. JAPAN

2F, Onoyakyobashi Bldg., 1-4-10, Kyobashi, Chuo-ku, Tokyo, 104-0031 Japan

81-3-3243-2031 www.functionbay.co.jp sales@functionbay.co.jp

China. FunctionBay CHINA

350 Xianxia Rd., Kechuang Bldg. Suite #229 Shanghai 200336, China

86-21-5240-0270 www.recurdyn.cn che-wei.chang@pro-lambda.com

Europe. FunctionBay GmbH.

Central Tower Landsbergerstr. 110 80339 Munich Germany

49-89-322-098-27 www.functionbay.de Info@recurdyn.de

Americas. MotionPort LLC

3143 S. 840 East, Suite 350, St. George, UT 84790 USA

1-435-767-9645 www.motionport.com brant.ross@motionport.com

System Requirements

- Windows 7, Windows 8, Window 10
 - SUSE Linux Enterprise Server (SLES 10 SP1, SLES 11 SP2)
 - Red Hat Enterprise Linux Server (RHEL 4.8, RHEL 5.8, RHEL 6.3)
- CPU 2.4GHz (Recommended : 3.4GHz, Quad Core or better)
- RAM 2GB (Recommended : 16GB or more)
- HDD 4GB (Recommended : 1TB)
- 1024x768 resolution or greater (Recommended : OpenGL 4.0,1920x1080)
- DVD-R or above

* RecurDyn is a trademark of FunctionBay, Inc. All other trademarks or registered trademarks belong to their respective holders.

* The included contents are available for RecurDyn V8R5 or later version. In addition, contents may be added or deleted in future versions.

* Some functions may not be fully supported on Windows 10.



FunctionBay